

DEPSTECH

HD WiFi Endoscope
User Manual

WF001-- (8.5mm)

Parts&Controls

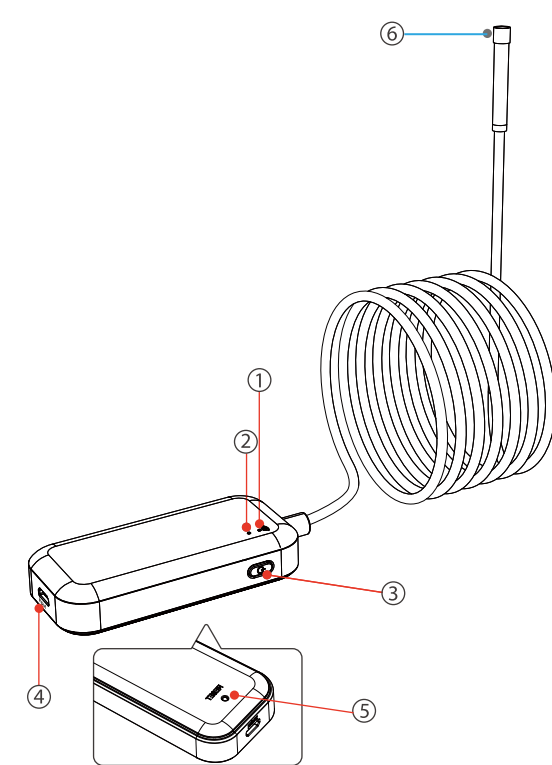

- 1) WiFi LED
- 2) Power LED
- 3) Power ON/OFF
- 4) Micro USB(For charging)
- 5) Reset
- 6) Camera Lens

Charge

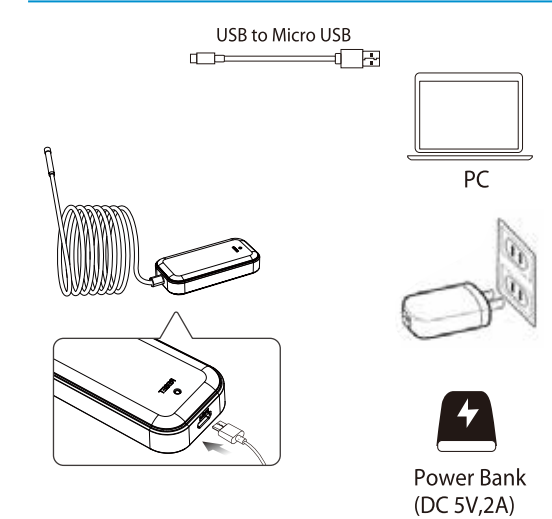

Via attached Micro USB to USB cable, connect the WiFi box to PC USB port or power bank port (DC5V 2A).

Notes:

- 1) When the WiFi box is being charged, the green indication light will be on.
- 2) The green light will be off when the box is fully being charged.

1

APP Installation

▼ For iOS:

please go to Apple Store to search "DEPSTECH" app.

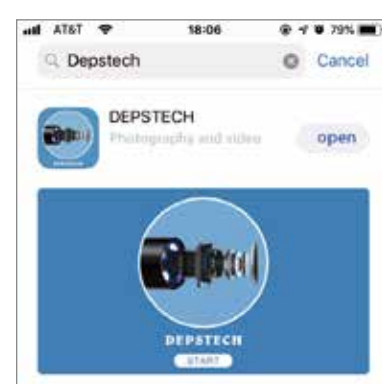

▼ For Android:

please go to Google Play Store to search "DEPSTECH-WIFI" app

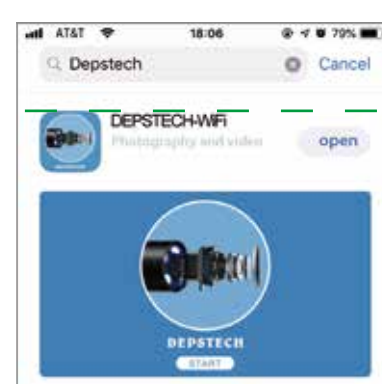

WiFi Connection

WiFi LED indication light on

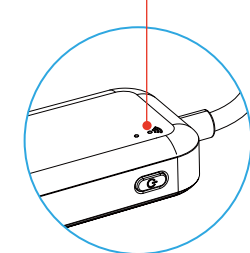

- 1) Turn on endoscope WiFi box, and WiFi LED indication light on the box will turn blue.

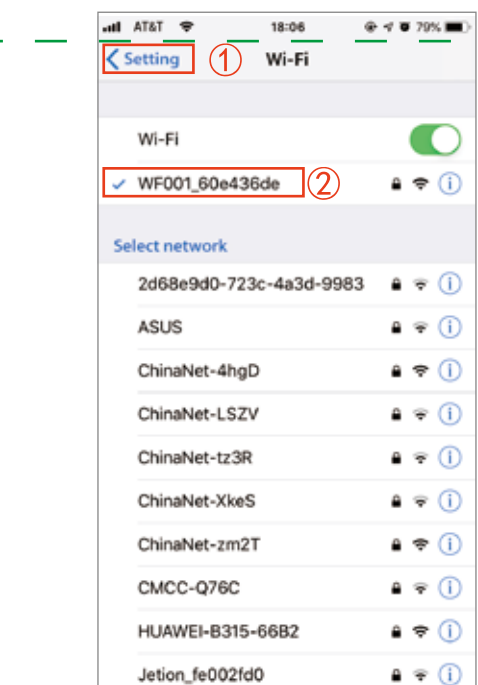

- 2) Go to PHONE SETTINGS to find WiFi signal from the endoscope WiFi box, instead of app settings.



- 3) Enter password "12345678" to connect to the signal like "WF001_*****" (***** will be a series of random numbers & letters in your use).

2

App Functions

▼ Capture Photos

- 1) After WiFi Connection, open the installed App on your device.
- 2) Click "📷" photo icon in the app to take photos from live feed.



▼ Record Videos

- 1) After WiFi Connection, open the installed App on your device.
- 2) Click "📹" photo icon in the app to take photos from live feed.



▼ View Directions



- 1) After WiFi Connection, open the installed App on your device.
- 2) Click "📏" icon in the app to change the direction of view

▼ Resolution Settings



- 1) Click "⚙️" settings icon in the app.



- 2) Choose the resolution according to the application.

▼ Modify Endoscope Default WiFi SSID & Password



- 1) After endoscope WiFi connection, enter the operating app.
- 2) Click "⚙️" settings icon in the app.

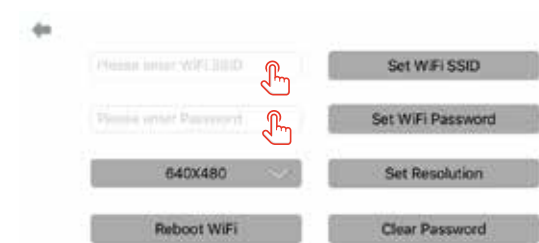

- 3) Set the new WiFi SSID and the password in the respective column.

3

Notes:

- 1) The new WiFi password must be within 8 characters either numbers or letters without any special marks like asterisk "*" or dash "-".
- 2) The device needs to be restarted after the modification
- 3) If not necessary, we do not advise our customers to change the original WiFi SSID and WiFi password for better using experience

▼ Browse the Captured Images & Videos



- 1) Enter the app and click "📁" files icon.
- 2) Browse the captured images & videos before.

Save the files on your device

▼ For Android Devices:

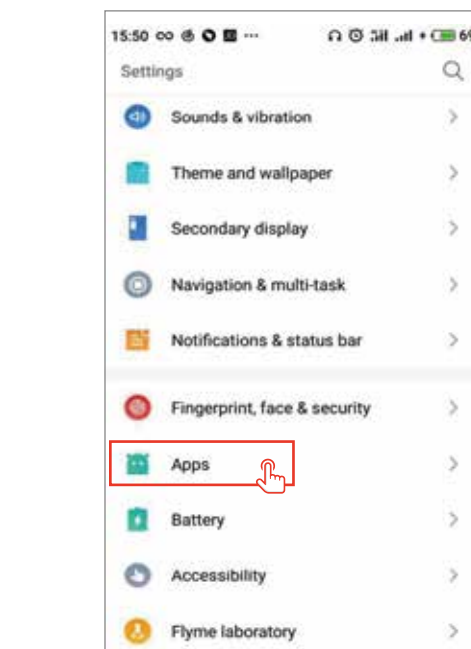

- 1) Go to phone settings and select Apps part.

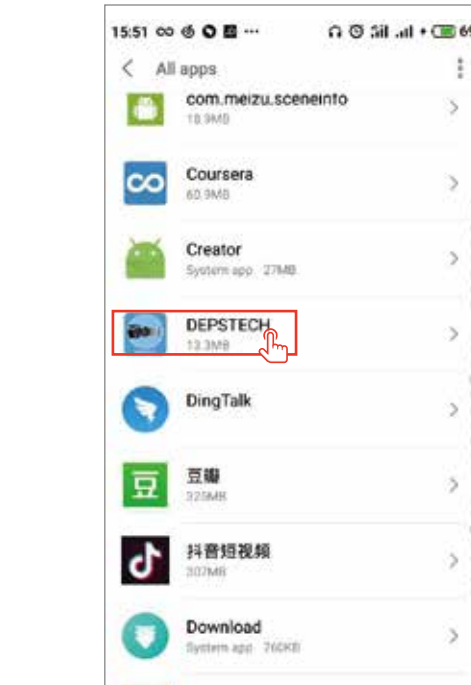

- 2) Find "DEPSTECH-WIFI" app.

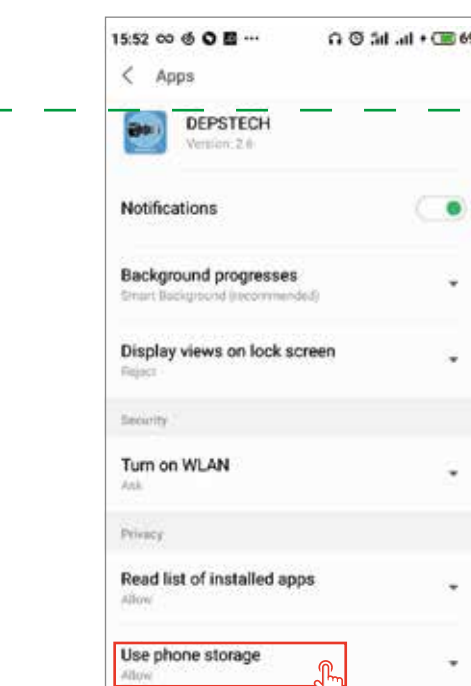

- 3) Allow the app use your phone storage
- 4) After the setting, the later captured images and videos will be stored on your phone.

4

▼ For iOS devices:



- 1) Go to phone settings and select "DEPSTECH" app part.



- 2) Enable the app accessible to Photos & Cellular Data.
- 3) After the setting, the later captured images and videos will be stored on your phone.

Attachment Installation



The three (3) included accessories (mirror, hook and magnet) are all attached to the camera in the same way as illustrated above.

Troubleshooting:

1) What if the WiFi connection fails or you forget the modified WiFi SSID or password?

- Please use a clip to press the reset button for 8 sec until the WiFi indication light flashes and turn off the box. Then, restart the endoscope and re-join its WiFi after the box is fully charged.
- Please keep the distance between WiFi box and mobile phone within 10 meters without any obstacles
- Keep the unit away from other strong WiFi signals around or turn off interfering WiFi signal nearby when using this WiFi endoscope.

2) Can not work via Bluetooth

In fact, the connection can only be used via Wi-Fi signal, not Bluetooth connection. Please connect the WiFi on your phone's setting.

3) What if no images show on App?

- Please make sure the WiFi connected.
- Turn off your cellular data on your phone.
- Try to restart the WiFi box and reconnect it with your phone.
- Exit the APP interface and re-enter.
- Try to uninstall the DEPSTECH APP, then re-install and update it.
- Change the device to have a try.
- The red "U" in the screen means that the endoscope is defective. Please contact us then.

4) Can not charge or the only 1-2 min working time after the fully charged

- Charge with other USB options
- Please turn off the Wi-Fi box when charging.

5

Precautions on safety

※ Prevent object and liquid entry. Liquid increases the risk of electrical shocks and damages to the product.

※ The unit is not shock-resistant. Do not use Depstech WiFi Endoscope as a hammer and avoid high impact.

※ The lens and the tube are water resistant when the unit is fully assembled, but the WiFi box is not. Do not immerse the WiFi box in water.

※ Do not use the camera if condensation forms inside the lens. Let the water evaporate before using again.

※ Turn on the WiFi Endoscope and place it in a dry environment if it is not in use.

※ Attention should be given to the environmental aspects of battery disposal.

※ It's normal that the camera will turn hot especially when the LED is in the brightest, but it will not affect the usage or life-span of the endoscope.

※ The WiFi transmission distance is about 10 meters without any obstacles. Please keep the distance between WiFi box and mobile phone within that distance.

※ Please note the camera probe is only IP67 waterproof which means it can only do underwater inspections for no deeper than 1 meter and no more than several minutes. Otherwise, it may damage the camera lens and affect image quality.

Specifications

Model	WF001
Imaging sensor	CMOS
Camera Resolution	1280x720, 640x480, 320x240
Horizontal View Angle	66
Camera Focal Distance	3cm-40cm (fixed focus, not zoom)
Diameter	8.5mm
Working voltage	DC5V/2A
Battery Capacity	450mAh
WiFi Transmission Distance	10 meters (without any obstacles)
Waterproof grade	IP67 (for lens/tube only)
Waterproofing grade	0°C-40°C

Package List

- 1x WiFi Endoscope
- 1x micro USB to USB adapter cable
- 1x mirror
- 1x hook
- 1x magnet

Contact

E-mail:
support@depstech.com(US)
support.ca@depstech.com(CA)
EUROPE

E-mail:
support.uk@depstech.com(UK)
support.de@depstech.com(DE)
support.es@depstech.com(ES)
support.fr@depstech.com(FR)
support.it@depstech.com(IT)

DEPSTECH
www.depstech.com
https://www.facebook.com/DEPSTECH.FANS/

6